

FOREDOM®

Operation and Maintenance Manual for K.1050 Brushless Micromotor Kit

HP7-7060
Foot Control



HP4-933
Cradle



HP4-717
Control



H.MH-150 Handpiece



For Your Safety:



Read this Manual before operating your
Foredom Micromotor Power Tool.



Always wear eye protection while
operating this Micromotor.

Safety Instructions



A Micromotor Handpiece is a high speed rotary power tool which can be dangerous and cause serious injury if it is not used properly. **NEVER** operate it without wearing eye protection.

- **ALWAYS** wear proper eye and face protection.
- **ONLY** use accessories rated for 50,000 rpm or higher speeds when operating this micromotor. Follow the Allowable Rotation Speed chart on page 9 of this manual for safe operation when using accessories with head diameters of more than 3/32" (2mm).
- **ALWAYS** observe the manufacturer's maximum speed rating when using any accessory.
- **NEVER** use or continue to use any accessory which appears to be damaged, loose, vibrating, bent, or out of balance. Inspect each accessory for cracks or flaws before use.
- **ALWAYS** insert the shank or arbor of an accessory or mandrel into the collet or chuck of the handpiece as far as possible in order to provide proper support and close the collet or chuck securely.
- **NEVER** use excessive side pressures which may tend to bend or break the shank or arbor of an accessory. Let the speed of the accessory do the work.
- **DO NOT** stall the motor by jamming or using excessive pressure on the mounted point, buff, wheel or accessory. This can result in damage to the motor.
- **WEAR** a dust protector, mask or respirator to prevent the inhalation of harmful dust or debris from grinding, carving or other operations performed with this power tool.
- **NEVER** operate with a damaged power cord. If the power cord or plug to the handpiece is damaged, repair or replace immediately.
- **USE** a dust collector (vacuum system) to pull sawdust, grinding dust, or other debris away from the work area and the micromotor intake vents.
- **NEVER** turn on or start the Handpiece while chuck is in open (unlocked) position. This can damage the handpiece. Make sure that a bur is installed and secured in the collet, that the spindle is NOT locked and that the bur can spin freely. Always operate and store it with a bur or other accessory in the chuck and with the chuck in the closed position.
- **DO NOT** operate the handpiece in the presence of any flammable liquid or gas.

Components

- 1** Control Unit (HP4-717)
- 2** Speed Display
- 3** Motor On/Off Switch
- 4** Motor On Indicator Light
- 5** Auto Cruise Switch
- 6** Auto Cruise On Indicator Light
- 7** Speed Control Knob
- 8** Forward/Reverse Selector Switch
- 9** Forward/Reverse Indicator Light
- 10** Hand/Foot Selector Switch
- 11** Hand/Foot Indicator Light
- 12** Power On/Off Switch & Light
- 13** Handpiece Plug Outlet
- 14** Foot Pedal Plug Outlet
- 15** Power Cord Plug Outlet
- 16** Fuse Holder with spare fuse
- 17** Test Bur
- 18** 3/32" Collet (1/8" is optional)
Collet part numbers and sizes are listed on page 7.
- 19** Handpiece (Brushless DC Micromotor H.MH-150)
- 20** Handpiece Motor Cord
- 21** Handpiece Cradle (HP4-933)
- 22** Handpiece Holder
- 23** Chuck Wrench
- 24** Foot Pedal (HP7-7060)
- 25** Foot Pedal Cord
- 26** Power Cord

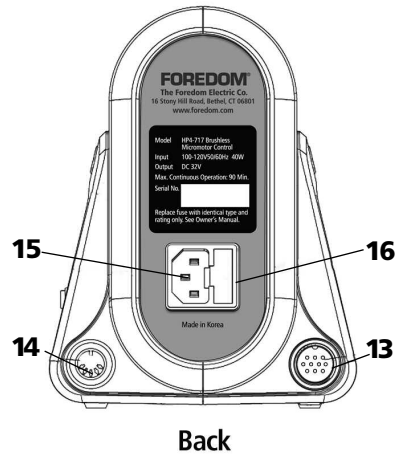
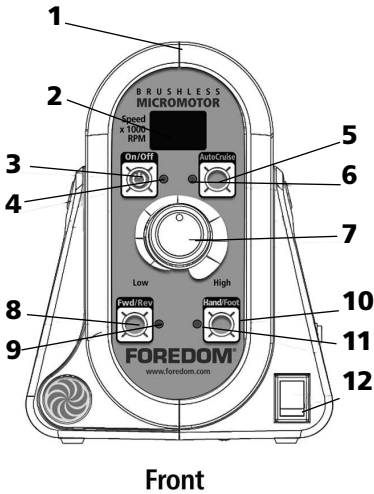

[Fig.2]

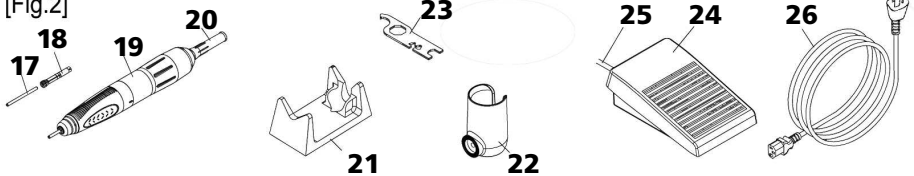

Complete Kit (Fig. 3)

Control Unit, Power Cord	Foot Pedal
Handpiece	Handpiece Cradle
Handpiece Holder,	Chuck wrench
Phillips Screw, Washer	

AC Power Input (Fig. 4)

1. Check the label on the rear of the Control Unit to make sure that the electrical specifications match your AC power.
2. If the fuse needs to be replaced (Fig. 6), replace it with identical type and rating only— 5x20mm,SLO-BLOW, 3.15A, 250V. For a 230V Micromotor use a 5x20mm,SLO-BLOW, 1.6A, 250V. The Fuse Holder **16** contains a spare fuse (Fig. 5).

CAUTION

- Never plug or unplug the Power Cord with wet hands to avoid electric shock.
- Use only with a grounded AC power receptacle.

Installation

CAUTION

- The Control Unit should rest on a flat, steady surface. Avoid blocking the ventilation openings in the bottom of the case.
- Use the Control Unit in locations that have a temperature below 100°F. Avoid excessively dusty, hot or humid locations.

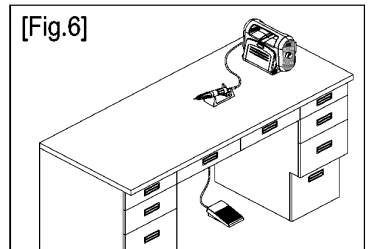
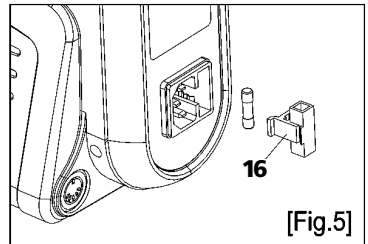
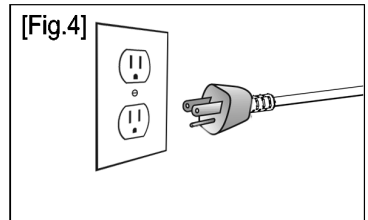
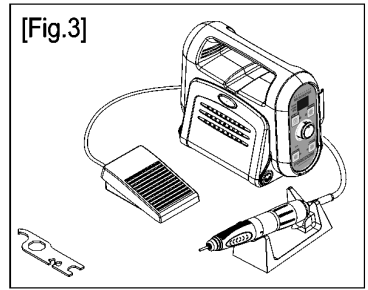

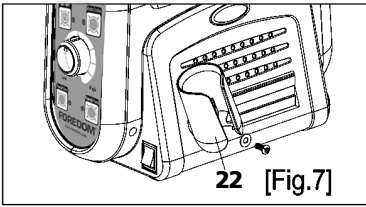

Set-up and Electric Connection

1. Fix the Handpiece Holder **22** to the right side of the Control Unit with screw and washer. (Fig.7).
2. Plug the Handpiece Motor Cord **20** into the Handpiece Motor Connector **13** located in the rear of the Control Unit and then tighten the plug nut. (Fig.8).
3. Plug the Foot Pedal Cord **25** into the Foot Pedal Outlet **14** located in the rear of the Control Unit. (Fig.8)
4. Plug the Power Cord **26** into the Power Connector **15** in the rear of the Control Unit. (Fig.8).

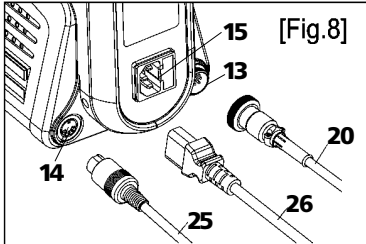

CAUTION

Make sure that all cords are connected safely and properly and that the Power Switch is off before plugging in the Power Cord.

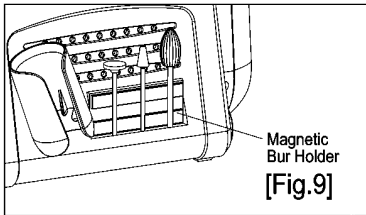

It is convenient to store burs on the surface of the magnetic bur holder strips located on the side of the controller. Some burs do not contain enough ferrous metal to attach to the magnet. (Protect from ferrous metal dust.) (Fig. 9).

Operation

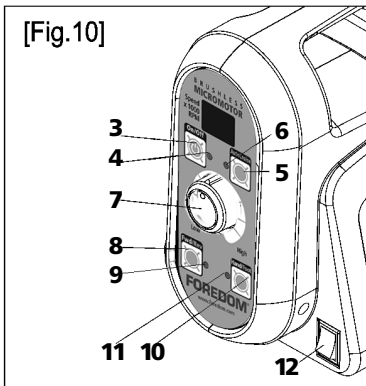

- a. Make sure that a bur is inserted in the motor handpiece and collet is fully closed.
- b. Set Power Switch **12** to off.
- c. Plug the Power Cord **26** into a grounded electric outlet.
- d. Set the Speed Control Knob **7** to the slowest position.
- e. Turn on the Power Switch **12**.
- f. Select the rotation direction by pressing Forward/Reverse Selector Switch **8**.



CAUTION Never switch rotation direction while the handpiece is running.

Hand Mode Operation, follow steps a. through f. above, then:

1. Press the Hand/Foot Selector Switch **10** to "Hand". (Hand/Foot Selector indicator light **11** lights up green.)
2. Press the Motor On/Off Switch **3** to run the motor. (Motor On/Off indicator light **4** lights up green.)
3. Set the Speed Control Knob **7** to desired speed.
4. Use the Motor On/Off Switch **3** to stop the motor.

Foot Mode Operation, follow steps a. through f. above, then:

1. Press the Hand/Foot Selector Switch **10** to "Foot". (Hand/Foot Selector indicator light **11** lights up orange, Motor On/Off indicator light **4** lights up green.)
2. Set the Speed Control Knob **7** to desired maximum speed.

continued

Foot Mode Operation continued

3. Press the Foot Pedal **24** to run the motor from start to a maximum speed (set by the speed control knob).
4. To increase speed, release foot pedal and allow motor to stop. Dial in new maximum speed and proceed.

In Foot Pedal Mode the micromotor will not exceed the preset speed.

Changing from Foot to Hand Mode

1. Press Hand/Foot selector switch, **10**.
2. Press Motor On/Off switch, **3** and select a speed using the control knob **7**.

Auto Cruise Mode

When the Foot Pedal is used, the Auto Cruise feature allows the speed to be maintained when the Foot Pedal is NOT pressed. Activate by pressing the Auto Cruise Switch **5** while keeping the Foot Pedal depressed, for 2 seconds at the desired speed. Deactivate by pressing the Foot Pedal.

Components

- | | | |
|--|--|--|
| 1 Control Unit (HP4-717) | 10 Hand/Foot Selector Switch | 19 Handpiece (Brushless DC micromotor H.MH-150) |
| 2 Speed Display | 11 Hand/Foot Indicator Light | 20 Handpiece Motor Cord |
| 3 Motor On/Off Switch | 12 Power On/Off Switch & Light | 21 Handpiece Cradle (No. HP4-933) |
| 4 Motor On Indicator Light | 13 Handpiece Plug Outlet | 22 Handpiece Holder |
| 5 Auto Cruise Switch | 14 Foot Pedal Plug Outlet | 23 Chuck Wrench |
| 6 Auto Cruise On Indicator Light | 15 Power Cord Plug Outlet | 24 Foot Pedal (HP7-7060) |
| 7 Speed Control Knob | 16 Fuse Holder with spare fuse | 25 Foot Pedal Cord |
| 8 Forward/Reverse Selector Switch | 17 Test Bur | 26 Power Cord |
| 9 Forward/Reverse Indicator Light | 18 3/32" Collet (1/8" is optional)
Collet part numbers and sizes are listed on page 7. | |

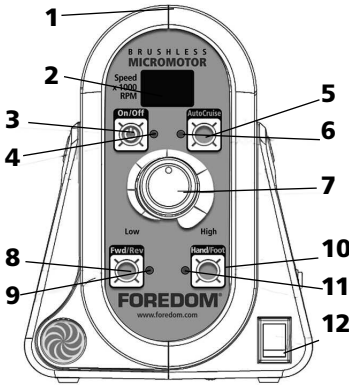

Front

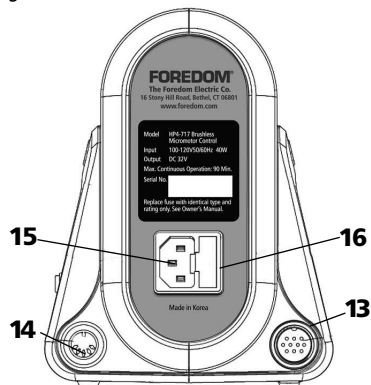

Back

[Fig.2]

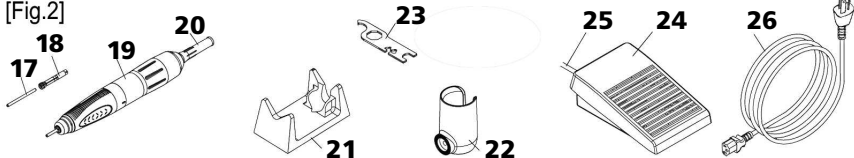



CAUTION

- Do not exceed the maximum operating speed of the bur or accessory in the handpiece to avoid personal injury.
- Before turning off the Power Switch, make sure that the motor has been stopped.
- When the unit is not in use, for maximum safety, unplug the Power Cord.

Rotation Speed Display Set Mode

NOTE: Use this set mode only when you wish to operate the micromotor handpiece with a lower maximum RPM rating.

This function is for setting a safe maximum rotation speed of the handpiece.

- Turn on the Power Switch **12** while pressing the Motor On/Off Switch **3** and wait for a beep. Release the Motor On/Off Switch.
- Set the maximum speed of the motor handpiece which you want to use by repeatedly pressing the Hand/Foot Selector Switch **10**.
- Return to the main mode by pressing the Motor On/Off Switch.

Motor On/Off Switch

"bc" displayed (Motor Handpiece)

Hand/Foot Selector Switch

25, 30, 35, 40, 45, 50 (x 1,000 rpm)

Maximum Torque Set Mode

This setting is used to match the maximum output of the control unit to the maximum torque capability of the handpiece, or to prevent damage to the bur. The maximum torque setting is preset at the factory to the recommended value. Use this procedure only if you are using another motor handpiece with a lower torque rating, or if you are using a bur which may be damaged by the full torque capability of the handpiece.

- Turn on the Power Switch **12** while simultaneously pressing Forward/Reverse Selector Switch **8** when you hear a beep, release the Forward/Reverse Selector Switch.
- Set the electric current (ampere) value for maximum torque of the motor handpiece by pressing Hand/Foot Selector Switch **10** repeatedly until the desired amperage value is displayed. The higher the current value, the more powerful the torque.

Fwd/Rev Switch

"c1" displayed

Hand/Foot Selector Switch

1a, 2a, 3a, 4a, 5a, 6a, 7a

Recommended

Up to 6a



CAUTION

- Do not select a current value which exceeds the rating of the motor handpiece. Too high a rating may shorten the motor life or damage the control unit. (Consult a qualified technician if possible.)

Note – To check the values of maximum rotation speed and maximum torque which are already set, turn on the Power Switch **12** while simultaneously pressing the Auto Cruise Switch **5**. The Set values are shown on the Speed Display LED **2** consecutively.

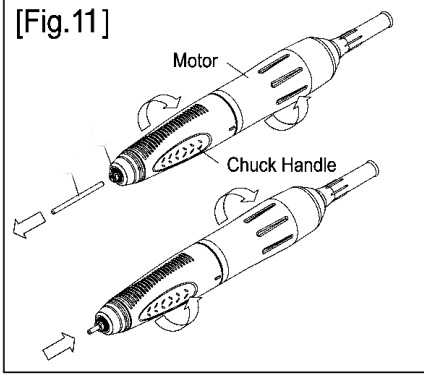

Using the Motor Handpiece (MH-150)

Changing Accessories

Burs and other accessories can be inserted or removed from the handpiece collet when the collet is open. To open the collet:

1. Turn off the motor using the Motor On/Off Switch **3** and the Power Switch **12**.
2. Twist the Chuck Handle in the "R" or release direction (clockwise) until the raised indicator bar **clicks** into the far left mark (⊙) on the silver center ring (Fig.11).

3. Remove the accessory and replace with another accessory. Insert the 'new' accessory shank fully (about 1/8") into the collet for maximum support. You should feel it touch the back of the collet.

4. Twist the knurled Chuck Handle toward the "S" or secure position by turning counter-clockwise until it snaps to lock the collet. The accessory and the collet will be able to spin freely. The raised collet indicator bar will be above the far right (<⊙) mark in the silver center ring.

Note: The intermediate position between "S" and "R" holds both the spindle and the accessory in a locked position. This is useful to unscrew an over-tightened mandrel screw.

Never turn the power on when the collet is open or in the intermediate position. The spindle is in the locked position and will not turn. This will damage the motor.

How to Remove and Install the Collet

1. With knurled Chuck Handle in "R" release position and bur or accessory in collet, place triangular hole in Chuck Wrench **23** over triangular flats of Collet head and unscrew the collet counter-clockwise (Fig. 12) Remove collet.

2. With bur or accessory in new collet, thread into handpiece. Place triangular hole in Chuck Wrench **23** over triangular flats of Collet head and tighten the collet clockwise. Be careful not to over-tighten. Test to insure that new collet releases accessory smoothly in the "R" released position. Test to insure that new collet holds firmly in the "S" secure position and spindle rotates freely.

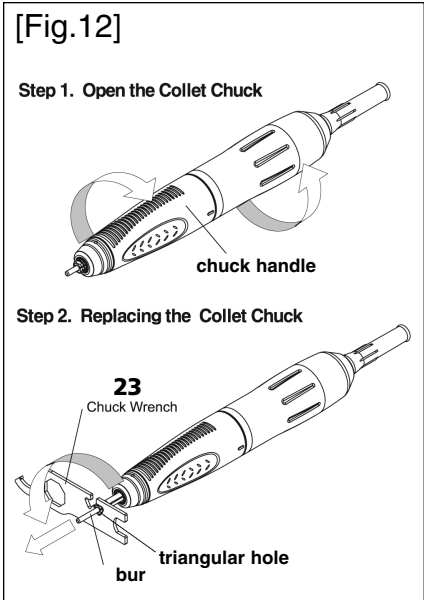

To order the correct Replacement or Additional Collet check the Handpiece Serial Number

Handpiece Serial Nos.	Collet Part No.	Collet Size
808xxxx and above	HP4-117	2.35mm (3/32")
	HP4-117B	3.18mm (1/8")
	HP4-117C	3.00mm
807xxxx and below	HP7-5008	2.35mm (3/32")
	HP7-5007	3.18mm (1/8")
	HP7-5006	3.00mm

[Fig.13A]

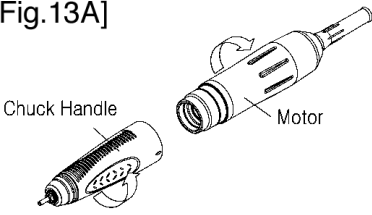

Disassembling the Chuck Handle and the Motor

The Chuck Handle and the Motor are disassembled by continuously turning the Chuck Handle counterclockwise (Fig.13A).

[Fig.13B]

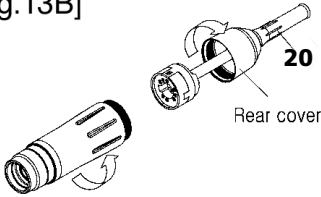

Detaching the Motor and the Motor Cord

Unplug Handpiece Motor Cord Assembly **20** from Handpiece Plug Outlet **13** on the back of the control. The Motor Cord Assembly **20** can be replaced by unthreading the Rear Cover from the Motor Housing (Fig.13B).



CAUTION

It is recommended that a bur be kept in the chuck at all times. Do not operate the handpiece without a bur in the chuck.

- Use only recommended burs.
- Always be sure chuck is free of dirt or debris before replacing a bur.
- After replacing a bur, make sure that the Collet Chuck is fully closed before running the Motor.
- DO NOT to open the collet while the motor is running. It will damage the handpiece.
- Always put the Handpiece on the Handpiece Cradle **21** or in Handpiece Holder **22** while not in use. (Fig.7). Take special care not to drop it on the floor.
- Thoroughly clean the Collet before reassembling. Clean at least once a week for longer life.
- Keep the Handpiece clean and free of dirt and debris during disassembly.
- The spindle and the motor should be disassembled only by a qualified repair facility.



CAUTION

- Never exceed the maximum rotation speed specified by the manufacturer or for the bur being used.
- Large burs, even when operated below maximum rated speed, may begin to vibrate. Speed should be reduced immediately to prevent damage to the bur, handpiece, or operator.
- Be sure to insert the Bur shank all the way, until it touches the back of the Collet Chuck. Then tighten the Collet Chuck. If the Bur is used while not inserted completely, it is very dangerous because vibration may cause it to come out, bend, or break.

Error codes

Error Code	Status	Cause
"1E"	Motor sensor error	<ol style="list-style-type: none"> 1. One or more hall sensors defective 2. The Motor Cord is unplugged or defective. 3. The Motor Cord is broken.
"2E"	Motor lock error	<ol style="list-style-type: none"> 1. The Collet Chuck is opened. 2. The Motor Handpiece is mechanically defective. 3. The Motor Handpiece is electrically defective.
"4E"	Motor overvoltage detection error	<ol style="list-style-type: none"> 1. The circuit of the Control Unit is defective.
"5E"	Overheat error	<ol style="list-style-type: none"> 1. The Control Unit has been operated under a high load condition for too long a time. 2. The Control Unit has been exposed to an excessively warm environment (more than 100°F.) 3. Air openings are blocked. 4. Temperature sensor is defective.
"6E"	Overload error	<ol style="list-style-type: none"> 1. The motor Handpiece was operated under an overload condition, or was stalled by jamming the bur into the work.
"7E"	Control Circuit Board error	<ol style="list-style-type: none"> 1. The circuit of the Control Unit is defective.

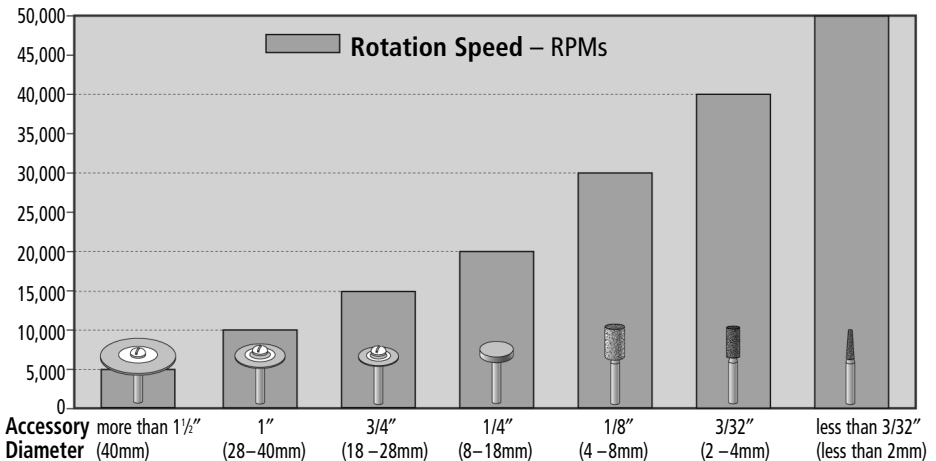

Allowable Rotation Speed

The chart is a general guide for the maximum rotation speed of conventional burs. The allowable rotation speed can be slightly different, depending on bur materials or types.

Troubleshooting

NOTE: When an error reading is displayed, turn off the power switch for a few seconds and then turn it on again. If "5E" is displayed wait for about ten minutes. If the error reading re-appears, follow the Troubleshooting Chart below.

Trouble	Check Points	Corrective Actions	
Power Lamp Does Not Light	Make sure that the Power Cord is correctly plugged into the outlet and the control unit.	Correctly plug in the Power Cord.	
	Check if the fuse is blown.	Replace only with the recommended fuse. If the fuse blows again, repair or replace the unit.	
	Make sure Power Switch is working properly.	Replace the Power Switch.	
Motor Does Not Run	"1E" displayed	Make sure Motor Cord is plugged in properly.	
	"2E" displayed	Check if the Collet Chuck is open.	
	"4E" displayed	The circuit of the Control Unit is defective.	
	"5E" displayed	Check if the Control Unit has been used at a high load and for a long time.	Turn off the Power Switch for about 10 mins., then restart the Control Unit. If error code continues repair or replace the control unit.
		Check for high workplace temperature.	If too warm, move the Control Unit to a location with an indoor temperature of 32~100°F.
		Check control air openings for blockage.	Unblock air opening.
		Temperature sensor is defective.	Replace the sensor.
	"6E" displayed	Check if the Control Unit has been excessively used under a high load condition.	Press the Auto Cruise Switch or turn off, then press the Motor On/Off Switch. If error code continues, repair or replace Control Unit.
		Check if the Collet Chuck is open.	If open, close it by turning the Chuck Handle.
		Make sure the shaft of the Motor Handpiece can rotate freely.	If it cannot be rotated with the chuck closed, the spindle of the Motor Handpiece is defective. Repair or replace it.
"7E" displayed	The circuit of the Control Unit is defective.	Turn off the Power Switch for about 10 mins., then restart the Control Unit. If error code continues repair or replace the control unit.	
Foot Pedal Does Not Work	Check if Foot Pedal Cord is properly plugged in.	Plug in the Foot Pedal Cord correctly.	
	The Hand/Foot Selector Switch is set to "Hand".	Set the Hand/Foot Selector Switch to "Foot".	
	Foot Pedal still does not work.	Repair or replace it.	
Handpiece overheats or is noisy while operating at no load	The ball bearings are defective.	Repair the Motor Handpiece.	
Motor Vibrates Excessively and is Unusually Noisy	Make sure that the Collet Chuck is free of dirt.	Thoroughly clean the Collet Chuck.	
	The rotation speed is too high.	Reduce the rotation speed. Refer to Allowable Rotation Speed chart.	
	Check if the bur shaft is bent, or bur is out of round or unbalanced.	Replace with a new bur.	
	Make sure that the ball bearings are in good condition.	Repair or replace the Motor Handpiece.	

Caution: Repairs should be performed only by qualified personnel.

Repair Services

Authorized repair service is available at the Foredom factory in Bethel, CT. Send items for repair to the factory marked "Attention: Repair Department". Enclose the item(s), a packing list, daytime phone number, return address, and information regarding the problem or repairs required.

Estimates of repair cost will be made upon request. It is our policy not to proceed with a repair without your approval if the cost (labor plus parts) is more than fifty percent of the cost for a new replacement. You will be notified by mail and advised of the cost to repair and to purchase a new replacement. Please allow three business days for an estimate to be done and five to seven business days for repair work to be completed after we receive your approval to proceed.

Please retain your proof of purchase for warranty repairs.

Warranty

Foredom warrants its product to be free of defects in material or workmanship for a period of two years after purchase.

During the warranty period, the defective product will be repaired or replaced without charge or, at our option, the purchase price will be refunded. This warranty does not cover damage caused in transit or by accident, misuse, or ordinary wear.

ALL IMPLIED WARRANTIES, INCLUDING BUT NOT LIMITED TO WARRANTIES OF FITNESS AND MERCHANTABILITY, ARE HEREBY LIMITED IN DURATION TO A PERIOD ENDING ONE YEAR FROM DATE OF PURCHASE, AND WE WILL NOT BE LIABLE OR RESPONSIBLE FOR ANY SPECIAL OR CONSEQUENTIAL DAMAGES.

Repair or replacement will be made at our option if the product is returned postpaid to:

The Foredom Electric Company, 16 Stony Hill Road, Bethel, CT 06801

All warranty repairs must be done at the factory at the address above. We will not pay any shipping or transportation charges.

This warranty only covers the original purchaser of the product. Proof of purchase may be requested.

Some states do not allow limitations on how long an implied warranty lasts, so the above limitation may not apply to you. This warranty gives you specific legal rights, and you may also have other rights which vary from state to state.

For More Information

For more information on Foredom machines, handpieces or accessories, contact your local dealer. When no local dealer is available, write, call or fax:

The Foredom Electric Company, 16 Stony Hill Road, Bethel, CT 06801
(203)792-8622, Fax: 203-796-7861 or Email: customerservice@blackstoneind.com

Visit our website: www.foredom.com